



Instructions for use STEAM OVEN

OCS8478G / BO4CS2T2-42

OCS8678G / BO6SA2T2-42

OCS8478GG / BO4CS2T2-42

OCS8678GG / BO6SA2T2-42

Pictograms used



Important information



Tip

CONTENTS

Your oven

Introduction	4
Control panel	5
Description	6
Guide rails/Telescopic guide rails	6
Accessories	6
Door	8
Cooling fan	8
Touch screen	8
Main displays	9
Function-setting display	11
Stand-by display	12

Initial use

Initial use	13
-------------	----

Operation

Using the 'Plus' menu	16
Opening the keyboard	18

Use

Oven function	19
Steam function	21
Using the 'Extras' functions	25
Functions table	29
Culisensor	34
Add steam	36
Delayed start	37
Stage cooking	39
Gratin	41
Additional functions	41
Settings	45

Cleaning

Cleaning the appliance	48
Steam clean	48
Cleaning the water tank filter	49
Descaling	49
Removing and cleaning the guide rails	50
Replacing the oven light bulb	50
Removing the oven door	51
Removing the oven door glass	52

Solving problems

General	53
---------	----

Your oven and the environment

Disposal of the appliance and packaging	55
---	----

Introduction

Congratulations on choosing this Asko steam oven. This product is designed to offer simple operation and optimum user-friendliness. The oven has a wide range of settings enabling you to select the correct cooking method every time.

This manual shows how you can best use this oven. In addition to information about operating the oven, you will also find background information that may be useful when using the appliance.



Please read the separate safety instructions carefully before using the appliance!

Read this manual before using the appliance and keep it in a safe place for future use.

Installation instructions are supplied separately.

Control panel

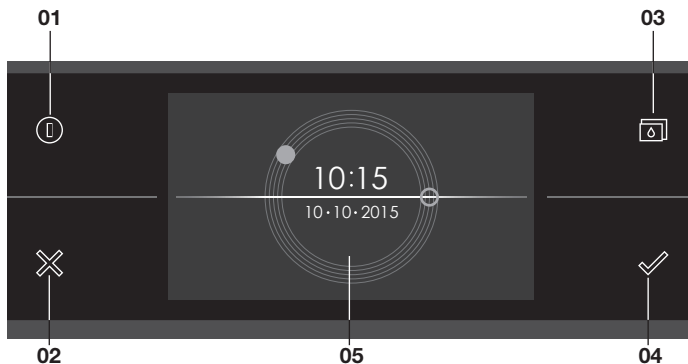

01. On/Off button; use to:
 - switch on the appliance.
 - switch to stand-by.
 - switch off the appliance. Keep the 'On/Off' key pressed until the appliance switches off.
02. X button; use to:
 - go a step back in the menu.
 - lose or answer 'No' to a pop-up menu.
 - lose or cancel a menu or function.
03. Water reservoir button; use to:
 - open the water reservoir valve.
04. Confirm key; use to:
 - confirm settings.
 - start a function.
 - close or answer 'Yes' to a pop-up.
05. Touch screen/display

YOUR OVEN

Description

1. Control panel
2. Water reservoir valve
3. Shelf levels
4. Oven door
5. Door handle

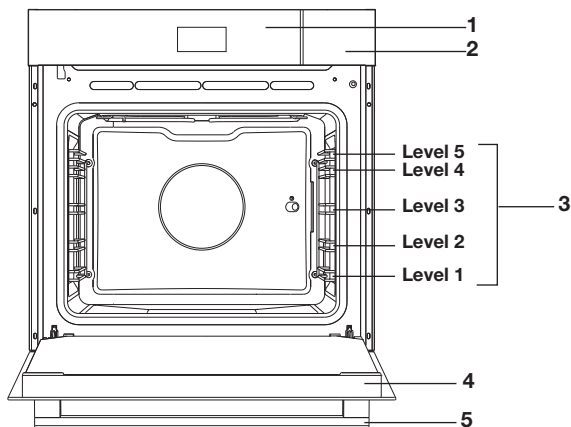

Guide rails/Telescopic guide rails





- The oven has four or five guide rails (Level 1 to 4/5), depending on the model. Level 1 is mainly used in combination with bottom heat. The two upper levels are mainly used for the grill function.
- Place the oven rack, baking tray or steam dish in the gap between the guide rail sliders.
- A number of shelf levels can have fully-retractable telescopic guide rails, depending on the model.
 - Pull the telescopic guide rails out of the oven cavity completely and place the oven rack / baking tray / steam dish on them. Then slide the oven rack / baking tray / steam dish on the telescopic guide rails, back into the oven cavity.
 - Only close the oven door when the telescopic guide rails have been returned completely back into the oven cavity.

Accessories

Your appliance is accompanied by a range of accessories, depending on the model. Only use original accessories; they are specially suited to your appliance. Be sure that all the accessories that are being used are able to withstand the temperature settings of the chosen oven function.

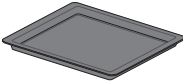
Note: not all accessories are suitable/available for every appliance (it may also differ by country). When purchasing, always provide the exact identification number of your appliance. Please see the sales brochures or check online for more details about optional accessories.

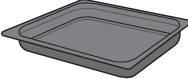
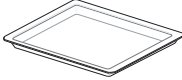
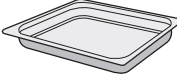
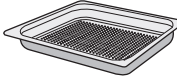
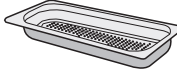
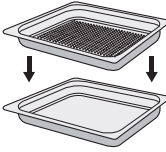
Note: never place an accessory on the bottom of the oven!

Accessories that can be supplied with your appliance (depending on the model)	
	<p>Enamelled baking tray; to be used for pastries and cakes.</p> <ul style="list-style-type: none"> • Do not use the enamelled baking tray for microwave functions! • Suitable for pyrolysis cleaning.
	<p>Oven rack; mainly used for grilling. A steam dish or pan with food can also be placed on the oven rack.</p> <ul style="list-style-type: none"> • The oven rack is equipped with a safety peg. Lift the rack slightly at the front to slide it out of the oven. • Do not use the oven rack for microwave functions!
	<p>Deep enamelled baking tray; to be used for roasting meat and baking moist pastry.</p> <ul style="list-style-type: none"> • Do not place the deep baking tray on the lowest level during a cooking process, except when using it as a drip tray during grilling, roasting or roasting with a spit roast (when available). • Do not use the deep enamelled baking tray for microwave functions! • Suitable for pyrolysis cleaning.
	<p>Glass baking tray; for microwave and oven use.</p> <ul style="list-style-type: none"> • NOT suitable for pyrolysis cleaning.
	<p>Non-perforated steam dish; 40 mm deep (useful for collecting moisture during steaming).</p> <ul style="list-style-type: none"> • Note: discolouration may occur at temperatures above 180 °C! This will not influence the proper function of the oven.
	<p>Perforated steam dish; 40 mm deep (useful for steam settings).</p> <ul style="list-style-type: none"> • Note: discolouration may occur at temperatures above 180 °C! This will not influence the proper function of the oven.
	<p>Perforated steam dish; 1/3GN. Perforated steam dish; 1/2GN.</p> <ul style="list-style-type: none"> • Note: discolouration may occur at temperatures above 180 °C! This will not influence the proper function of the oven.
	<ul style="list-style-type: none"> • The steam dishes can be used simultaneously on two levels. Place the perforated steam dish in the middle of the oven and the non perforated steam dish one level below the perforated steam dish. • For steaming you can place the perforated steam dish in the non-perforated steam dish. They can only be used together on a level with telescopic guide rails.
	<p>Culisensor; can be used to measure the core temperature of the dish. When the desired temperature is reached, the cooking process will be stopped automatically.</p>

YOUR OVEN

Door

- The door switches interrupt the operation of the steam oven when the door is opened during use. The oven continues operating when the door is closed.
- This oven has a 'Soft close door system'. When closing the oven door, this system dampens the movement, from a certain angle, and silently closes the oven door.

Cooling fan

The appliance is equipped with a cooling fan that cools the casing and control panel.

Touch screen

- Operate your oven's touch screen by tapping or swiping it.
- Tap the display to open a function or adjust a setting.
- Swipe the display for further information/show options or adjust a setting.

Tapping:

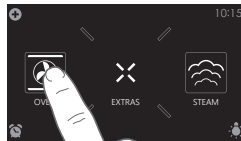

Swiping:



For the best response, touch the buttons with the main part of your fingertip. Every time you tap a button during use, a short tone will sound (unless this is adjusted in the settings).

Main displays

Start display

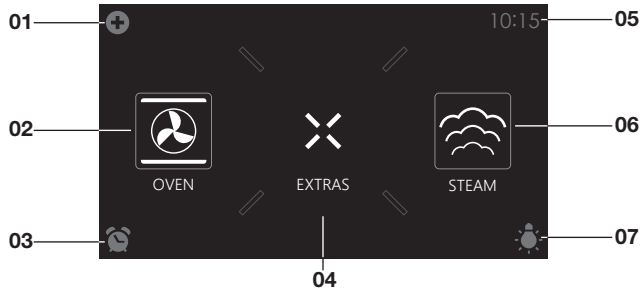

Plus menu (01)

- Tap the plus symbol to open the 'Plus' menu. The contents of this menu changes according to the control options available at that time.

Oven (02)

- Tap 'OVEN' to open the oven function menu.

Egg timer (03)

- Tap the egg timer symbol to open the egg timer menu.
- The egg timer can be used independently from the oven function.
 - The longest possible timer setting is 24 hours.
 - When an egg timer goes off, a pop-up will appear and an acoustic signal will sound.
 - Tap on the X button, confirm button or the display to switch off the signal and close the pop-up menu. The sound signal will stop automatically after approximately 1 minute.

Extras (04)

- Tap on 'EXTRAS' to show the appliance's extra functions.

Time (05)

- The time is shown here.

Steaming (06)

- Tap on 'STEAM' to open the steam function menu.

Light (07)

- Tap on the 'lamp' symbol to switch the oven light on or off.
- The oven light will also light up when you open the oven door or start cooking. The oven light will dim automatically (unless this is adjusted in the settings).

Extras display

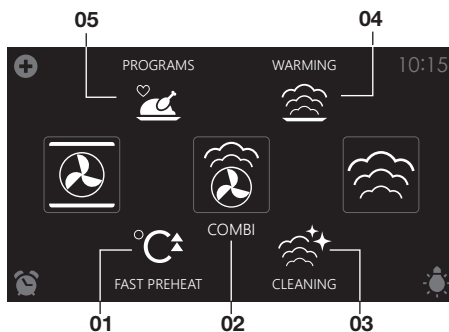

Fast preheat (01)

- Tap on 'FAST PREHEAT' to open the fast preheat function.

Combi (02)

- Tap on 'COMBI' to open the combi function menu.

Cleaning (03)

- Tap on 'CLEANING' to open the cleaning function menu.

Warming (04)

- Tap on 'WARMING' to open the warming function menu. Plate warming, regenerate, defrost and keep warm can be found here.

Programs (05)

- Tap on 'PROGRAMS' to open the program menu. The favourites and automatic programs can be found here.

Function-setting display

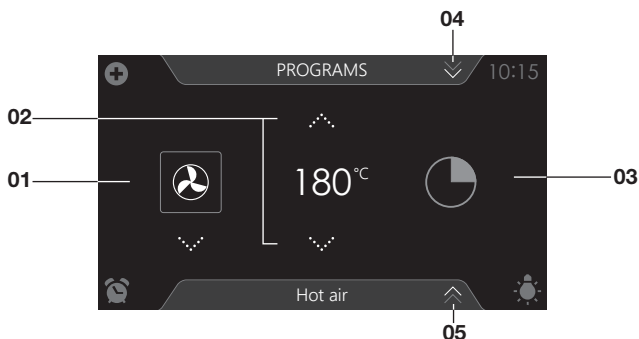

Selecting a function (01)

- Tap on the arrows above and below the function or sweep over the symbol to select a function (see also 'Opening the Keyboard').

Setting the temperature (02)

- Tap on the arrows above and below the temperature or sweep over the temperature indicator to select a temperature (see also 'Opening the Keyboard').

Cooking time (03)

- Tap the cooking time symbol if you want to set a cooking time. If a cooking time is already stated, it is necessary to set this.
- Tap on the arrows above and below the time or swipe over the time to adjust it (see also 'Opening the Keyboard').

Programs (04)

- Tap on 'PROGRAMS' to open the program menu.
The favourites and automatic programs can be found here.

Info tab (05)

- The name of the selected function appears in the bottom tab of the display. Tap on the tab to request more information about the selected function.

Stand-by display

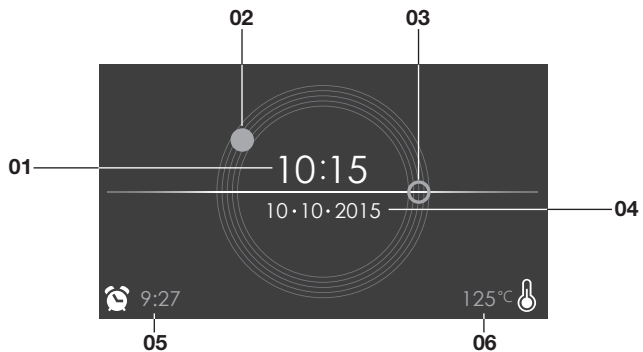

Display time (digital/01)

- Actual time of day.

Display time (analog/02 and 03)

- Actual time of day.
- The hour hand of the analog clock is indicated with a 'closed' circle (02) and the minute hand with an 'open' circle (03).

Display of date (04)

- Actual date.

Display egg timer (05)

- The expiring egg timer.

Display descending temperature (06)

- Actual temperature in the oven (waste heat).

Initial use

- Clean the oven interior and accessories with hot water and washing-up liquid. Do not use aggressive cleaning agents, abrasive sponges and similar.
- The oven will emit a particular odor when it is used for the first time; this is normal. Make sure that there is good ventilation during initial use.



When the appliance is plugged in for the first time or after the appliance was disconnected from the mains for a longer period of time, you have to set 'Language', 'Time', 'Date' and 'Water hardness'.

Setting the language

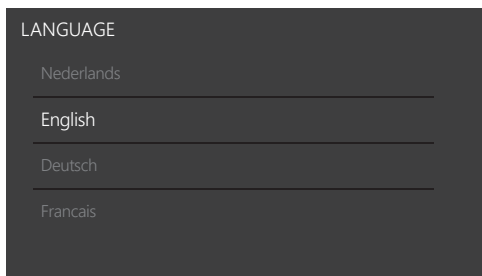

Set the desired language in which the appliance's display texts will appear. The default setting is 'English'.

1. Swipe over the display to view all languages.
2. Tap on a language to select this.
3. Press on the confirm button to save the set language.



Setting the time

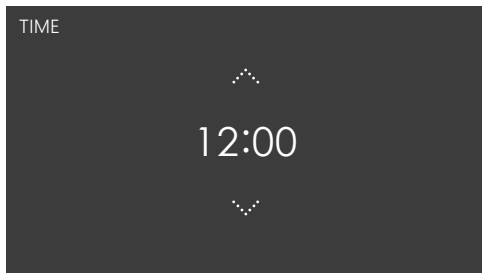

1. Tap on the arrows above and below the time or swipe over the time to adjust it.
2. For fast entry, tap in the centre of the time display; a pop-up keyboard will appear on which the desired time can be typed (see 'Opening the Keyboard' chapter).
3. Press on the confirm key to save the set time.



Setting the date

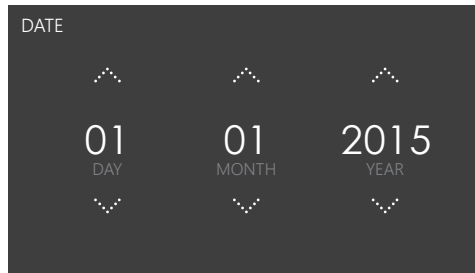

1. Tap on the arrows above and below the day, month or year or swipe over the day, month or year to adjust these.
2. Press on the confirm button to save the set date.



Setting the water hardness



The water hardness must be set prior to initial use. If the water is softer or harder than the default setting, you can alter the set hardness level.

Checking the water hardness

You can measure water hardness using the 'paper test strip' supplied with your appliance. For information about water hardness in your region please contact your local water board.

Using the 'paper test strip'

Dip the test strip in water for 1 second. Wait 1 minute and read the number of bars on the paper strip. Check the table for the correct water hardness setting.

Setting the water hardness

1. Compare the test strip with the image on the display.
2. Tap the bars on the display until they concur with the test strip.
3. Press on the confirm button to save the set water hardness.



The equipment has now been programmed so that the descaling notification will appear in accordance with the actual water hardness.

Display	Test strip number/colour of the bars	Type	PPM	French hardness (°df)	German hardness (°dH)
1	4 green bars	Very soft water	0 - 90	0 - 9	0 - 5
2	1 red bar	Soft water	90 - 178	9 - 18	5 - 10
3	2 red bars	Rather hard water	178 - 267	18 - 26	10 - 15
4	3 red bars	Hard water	267 - 356	26 - 35	15 - 20
5	4 red bars	Very hard water	> 356	> 35	> 20

The appliance is now ready for use.



The language, time, date and water hardness can be adjusted in the settings menu (see 'Settings' chapter). The settings menu can be opened from the start display via the 'Plus' menu.

Using the 'Plus' menu

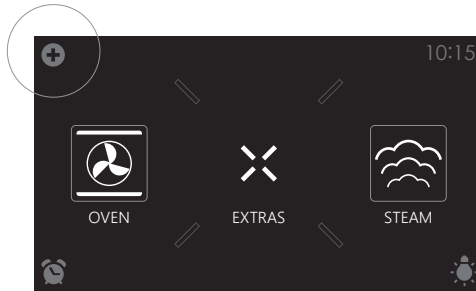

The 'Plus' menu comprises a number of functions or settings. The offered plus functions depend on the display that is active.

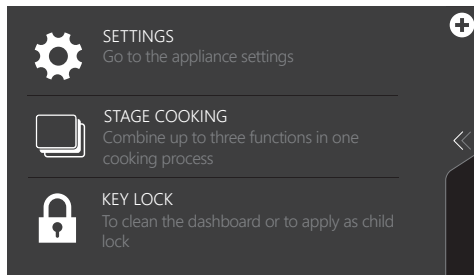

- From the start display, the following functions/menus can be found in the 'Plus' menu:
 - **Settings;** Set your preferences (see 'Settings' chapter).
 - **Stage cooking;** Combine up to three functions in one cooking process (see 'Stage cooking' chapter).
 - **Key Lock;** Lock all the keys to clean the dashboard or to prevent that the appliance gets into progress accidentally. Hold the key pressed until the key lock is enabled.

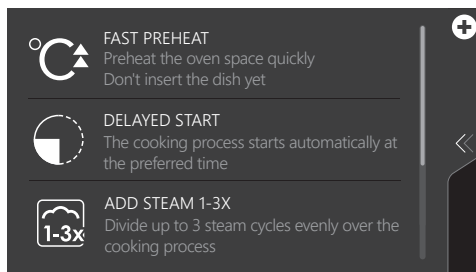

- From the oven-, steam or combi function-settings display, the following functions can be found in the 'Plus' menu:
 - **Fast preheat;** Preheat the oven space quickly to the desired temperature within a cooking process (see 'Fast preheat' chapter). Not available in steam function.
 - **Delayed start;** The cooking process will start automatically at the time you set.
 - **Add steam 1-3X;** Add a steam cycle to the cooking process 1, 2 or 3 times (only present in oven function).
 - **Stage cooking;** Combine up to three functions in one cooking process (see 'Stage cooking' chapter).
 - **Key Lock;** Lock all the keys to clean the dashboard or to prevent that the appliance gets into progress accidentally. Hold the key pressed until the key lock is enabled.
 - **Gratin;** To add the grill function at the end of the progress (gratin time will be added at the end of the cooking process).

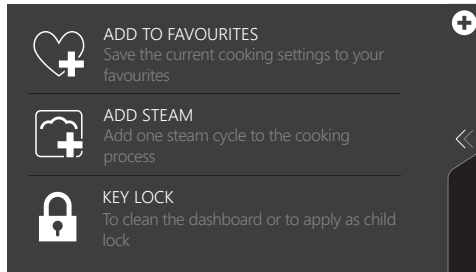

- When an oven-, steam or combi function is started, the following functions can be found in the 'Plus' menu:
 - **Add to favourites;** Add the settings for the cooked dish to your favourites (see 'Additional functions' chapter).
 - **Add steam;** Add a steam cycle to the cooking process (only present in oven function).
 - **Key Lock;** Lock all the keys to clean the dashboard or to prevent that the appliance gets into progress accidentally. Hold the key pressed until the key lock is enabled.
 - **Gratin;** To add the grill function at the end of the progress (gratin time will be added at the end of the cooking process).

Opening the keyboard

A keyboard can be opened for fast entry of a function, temperature or cooking time. A quick setting can be selected with this or a value can be entered.



1. Tap in the centre of the function symbol, temperature or cooking time (activated). The keyboard appears.

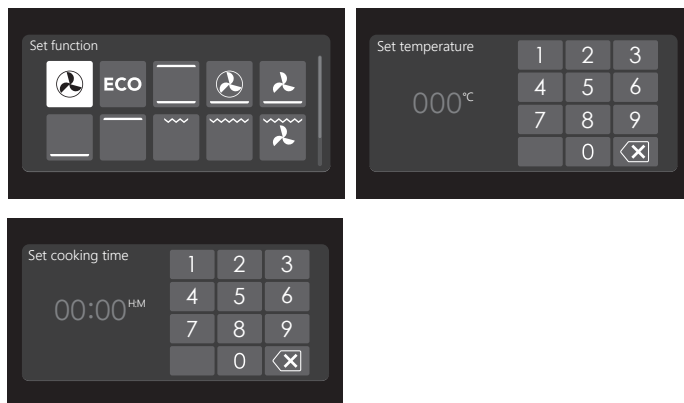

2. Enter the desired value or tap the desired value.
3. If the set value is not confirmed automatically, press on the confirm key to confirm the entry.

Oven function

Use the oven function menu to cook dishes using, for instance, hot air, bottom heat and grill.

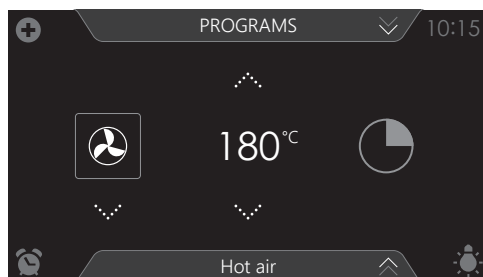

- Various oven functions can be selected.
- A temperature and a cooking time can be set for each oven function.
- Plus menu functions such as fast preheat, stage cooking and delayed start can also be selected. Tap on the plus symbol for this. See the 'Using the 'Plus' menu' chapter.

Using an oven function

Select the oven function appropriate for the meal you are cooking. Consult the Functions table for this. You can also consult the info tab. Tap on the tab at the bottom of the display to request more information about the selected function.

1. Switch on the oven using the 'On/Off' button.
2. Place the dish in the oven.
3. Tap 'OVEN' to open the oven function menu.
4. Select an oven function (see 'Function-setting display' chapter).
5. Select a temperature (see 'Function-setting display' chapter).
6. Tap the 'cooking time' symbol and select a cooking time (see 'Function-setting display' chapter).



Cooking can also be started without a cooking time being set. You should then skip step 6.

7. Select any additional settings using the 'Plus' menu (for example fast preheat).
8. Start cooking the dish using the confirm button.



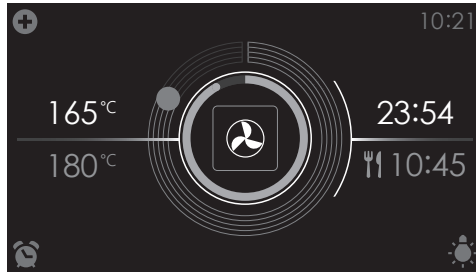

- The following values can now be read in the display:
 - current temperature (165 °C)
 - set temperature (180 °C)
 - status indicator time (outer circle)
 - status indicator temperature (inner circle)
 - cooking time (23:54)
 - end time (10:45)



- Tap in the middle of the display during cooking to open a pop-up display with settings. Adjust these if desired.
- At the end of a dish's cooking time a sound signal will sound. The signal can be switched off by opening the oven door or pressing a button.
- The selected settings can be saved in 'Favourites'. For this open 'ADD TO FAVOURITES' from the 'Plus' menu (See 'Saving a cooking method' in the 'Additional functions' chapter).



Display view at the end of cooking.

Steam function



Warning – Risk of scalding! Leave the door closed during steam functions, hot steam can escape in case of opening. Condensation in the oven will increase when opening the door.



Note: Let the oven cool down after every steam function and dry the inside of the oven with a soft cloth.



Note: The water system empties each time the steam function is finished. This action is audible and is part of the steam oven's normal operation.

Advantages of steam cooking

- Healthy and natural, steam cooking retains the colour and taste of the dish. No odors are released using this cooking method.
- Steam cooking (stewing, cooking, roasting) starts before the oven temperature reaches 100 °C.
- Slow cooking (stewing, cooking, roasting) is also possible at lower temperatures. It is healthy: vitamins and minerals are preserved as only a small proportion of these dissolve in the hot moisture of the dish.
- It is not necessary to add any form of fat or oil during steam cooking.
- Steam does not distribute smell or taste, enabling meat or fish to be cooked together with vegetables.
- Steam is also suitable for blanching, defrosting and warming or keeping a dish warm.

Sous vide

Using the sous vide steam function:

- Vacuuming
 - First vacuum the food in plastic using the Asko vacuuming drawer. This process removes most of the air from the plastic bag. The bag preserves nutrients and taste during cooking, resulting in food that is juicier, softer and tastier.
- Vacuum cooking
 - Cook the dish at the correct temperature and the correct time using the oven's Sous Vide steam setting (see 'recipes and cooking times').
 - Most dishes can be kept at serving temperature (around 60 °C) for a few hours, which makes mise en place very easy: you simply remove the dish from the oven when you need it.

Filling the water reservoir

Always fill the reservoir with clean and cold tap water, bottled water without added minerals or distilled water suitable for consumption.

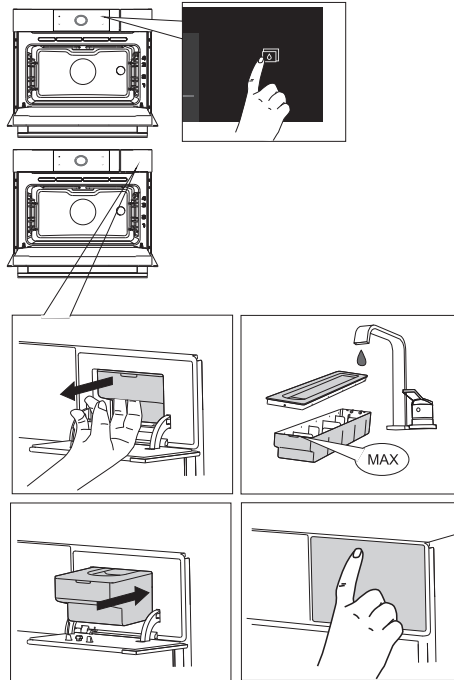

1. Press the 'water reservoir' button to open the water reservoir cover.
2. Use the handle to remove the reservoir from the oven.
3. Remove the water reservoir lid and clean the water reservoir with clean water.
4. Fill the reservoir with water up to the 'MAX' mark on the reservoir (around 1.2 litres).
5. Push the water reservoir back in the oven until a click is heard (position switch is activated).
6. Close the water reservoir cover.



Any water remaining in the steam system after cooking will be pumped back into the water reservoir. Empty, clean and dry the water reservoir. Only fill the reservoir just prior to using it!

Using a 'Steam' oven function

Select the steam function appropriate for the meal you are cooking. Consult the Functions table for this. You can also consult the info tab. Tap on the tab at the bottom of the display to request more information about the selected function.

1. Switch on the oven using the 'On/Off' button.
2. Place the dish in the oven.
3. Tap on 'STEAM' to open a steam function menu.

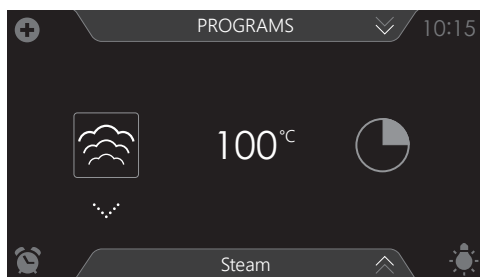

4. Select a steam function (see 'Function-setting display' chapter).
5. Select a temperature (cannot be set for the 'Steam' function). See 'Function-setting display' chapter.
6. Tap the 'cooking time' symbol and select a cooking time (see 'Function-setting display' chapter).



Cooking can also be started without a cooking time being set. You should then skip step 6.

7. Select any additional settings using the 'Plus' menu (for example delayed start).
8. Start cooking the dish using the confirm button.



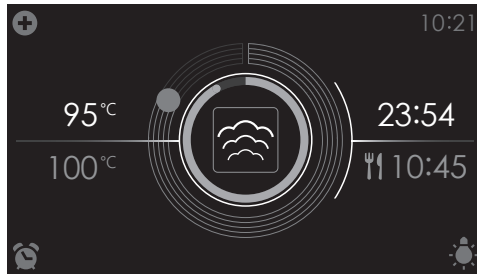

- The following values can now be read in the display:
 - ▷ current temperature (95 °C)
 - ▷ set temperature (100 °C)
 - ▷ status indicator time (outer circle)
 - ▷ status indicator temperature (inner circle)
 - ▷ cooking time (23:54)
 - ▷ end time (10:45)



- *Tap in the middle of the display during cooking to open a pop-up display with settings. Adjust these if desired.*
- *At the end of a dish's cooking time a sound signal will sound. The signal can be switched off by opening the oven door or pressing a button.*
- *The selected settings can be saved in 'Favourites'. For this open 'ADD TO FAVOURITES' from the 'Plus' menu (See 'Saving a cooking method' in the 'Additional functions' chapter).*

Using the 'Extras' functions

Open the 'Extras' display to open the combi function menu or to preheat the oven quickly. A cleaning program, warming functions or automatic programs can also be selected.

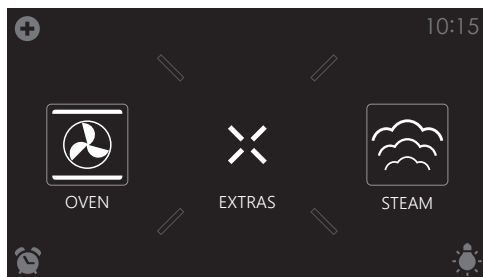

Tap on 'EXTRAS' to show the appliance's extra functions.

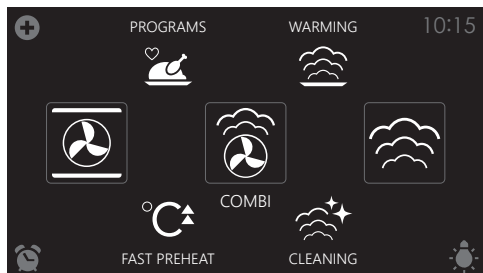

The following programs can now be selected:

- Fast preheat
- Combi
 - Hot air + Steam level 1
 - Hot air + Steam level 2
 - Hot air + Steam level 3
- Cleaning (see 'Cleaning' chapter)
 - Steam clean
 - Descaling
- Warming (see 'Additional functions' chapter):
 - Regenerate
 - Plate warming
 - Defrost
 - Keep warm

- Programs (see 'Additional functions' chapter):
 - Favourites
 - Automatic programs

Fast preheat

Use this oven function for preheating the oven quickly. Don't insert a dish during Fast preheat. When the oven is heated to the set temperature, preheating is finished and the oven is ready to cook the dish.

Using fast preheat

1. Switch on the oven using the 'On/Off' button.
2. Tap on 'EXTRAS' to show the appliance's extra functions.
3. Tap on 'FAST PREHEAT' to open the fast preheat function.

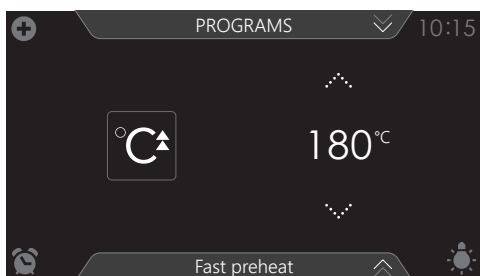

4. Select a temperature (see 'Function-setting display' chapter).
5. Start the fast preheat function using the confirm button.

- *Fast preheat can also be linked to a cooking process.*
- *Activate 'FAST PREHEAT' from the 'Plus' menu to do so.*
- *When the set temperature is reached, a pop-up will appear and a sound signal sounds.*
- *The cooking time starts counting up or down after door closing.*

Combi

- 3 different combi steam functions can be selected.
 - Hot air + Steam level 1
 - Hot air + Steam level 2
 - Hot air + Steam level 3
- A temperature and a cooking time can be set for each combi function (see 'Steam tables' chapter).
- 'Plus' menu functions such as 'stage cooking' and a delayed start can also be activated. Tap on the plus symbol for this. See the 'Using the 'Plus' menu' chapter.

Using a combi function

Select the combi function appropriate for the meal you are cooking. Consult the Functions table for this. You can also consult the info tab. Tap on the tab at the bottom of the display to request information about the current function.

1. Switch on the oven using the 'On/Off' button.
2. Place the dish in the oven.
3. Tap on 'EXTRAS' to show the appliance's extra functions.
4. Tap on 'COMBI' to open the combi function menu.

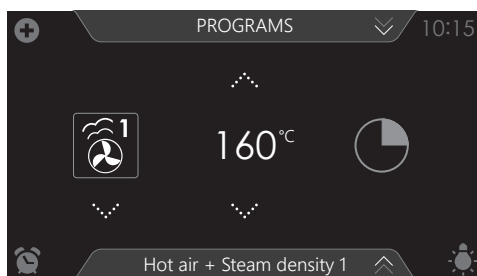

5. Select a combi function (see 'Function-setting display' chapter).
6. Select a temperature (see 'Function-setting display' chapter).
7. Tap on the 'cooking time' symbol and select a cooking time (see 'Function-setting display' chapter).



Cooking can also be started without a cooking time being set. You should then skip step 6.



8. Select any additional settings using the 'Plus' button.
9. Start cooking the dish using the confirm button.

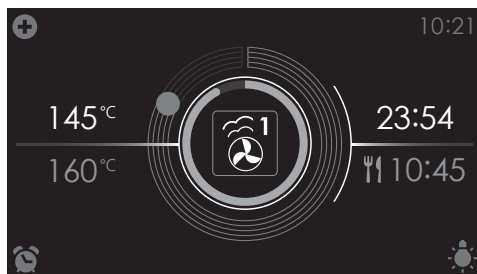





- The following values can now be read in the display:
 - current temperature (145 °C)
 - set temperature (160 °C)
 - status indicator time (outer circle)
 - status indicator temperature (inner circle)
 - cooking time (23:54)
 - end time (10:45)





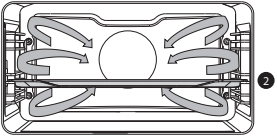

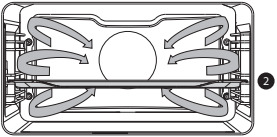

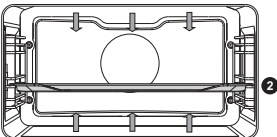

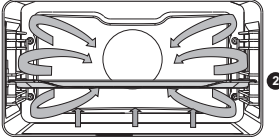

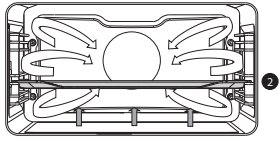

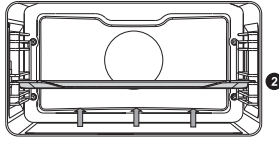
- Tap in the middle of the display during cooking to open a pop-up display with settings. Adjust these if desired.
- At the end of a dish's cooking time a sound signal will sound. The signal can be switched off by opening the oven door or pressing a button.
- The selected settings can be saved in 'Favourites'. For this open 'ADD TO FAVOURITES' from the 'Plus' menu (See 'Saving a cooking method' in the 'Additional functions' chapter).

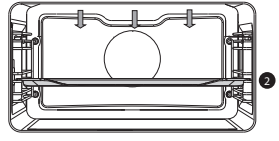



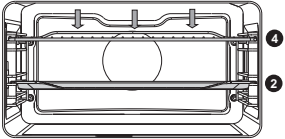

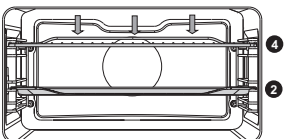
Functions table

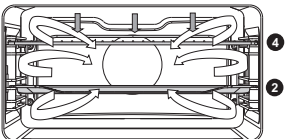

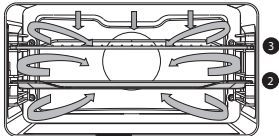

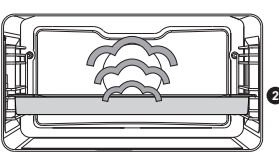

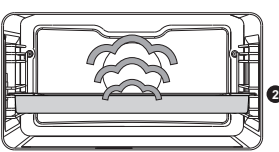

Consult the table to choose the desired function. Also consult the instructions for preparation on the dish packaging.

Function	Description	
Oven functions		
	<p>Hot Air</p> <ul style="list-style-type: none"> • Heating by means of hot air from the back of the oven. • This mode provides uniform heating and is ideal for baking. • Place the baking tray or oven rack in the middle of the oven. • Suggested temperature: 180 °C • Preheating is recommended. 	
	<p>ECO Hot air</p> <ul style="list-style-type: none"> • Heating by means of hot air. ECO hot air uses less energy but gives the same result as the hot air setting. Cooking takes a few minutes longer. • This mode can be used for roasting meat and baking pastry. • Place the baking tray or oven rack in the middle of the oven. • Suggested temperature: 180 °C • This setting makes use of the residual heat (heating is not on the whole time) to achieve low energy consumption (in accordance with energy class EN 60350-1). In this mode the actual temperature in the oven is not displayed. 	
	<p>Top + Bottom heat</p> <ul style="list-style-type: none"> • Heating by means of the upper and lower heating elements. • This mode can be used for traditional baking and roasting. • Place the baking tray or oven rack in the middle of the oven. • Suggested temperature: 200 °C • Preheating is recommended. 	

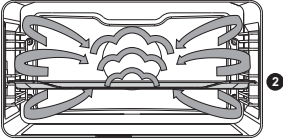
Function	Description	
	<p>Hot air + Bottom heat</p> <ul style="list-style-type: none"> • Heating by means of hot air from the back of the oven and the bottom heating element. • This mode can be used to bake pizza, moist pastry, fruitcakes, leavened dough and short crust. • Place the baking tray or oven rack in the middle of the oven. • Suggested temperature: 200 °C • Preheating is recommended. 	
	<p>Bottom heat + Fan</p> <ul style="list-style-type: none"> • Heating by means of the lower heating element. The heat is distributed by the fan. • This mode can be used for baking low leavened cakes, as well as for preservation of fruit and vegetables. • Place a not too high baking tray in the lower part of the oven, so that hot air can also circulate over the upper surface of the food. • Suggested temperature: 180 °C 	
	<p>Bottom Heat</p> <ul style="list-style-type: none"> • Heating only by means of the lower heating element. • This mode can be used with dishes and baked goods that require a distinctive bottom crust or browning. • Place the baking tray or oven rack in the lower part of the oven. • Use just before the end of the baking or roasting time. • Suggested temperature: 160 °C 	
	<p>Top Heat</p> <ul style="list-style-type: none"> • Heating only by means of the upper heating element. • This mode can be used when you wish to bake/roast the top part of your dish. • Place the baking tray or oven rack in the middle of the oven. • Suggested temperature: 150 °C 	

Function	Description	
	<p>Grill</p> <ul style="list-style-type: none"> • Heating by means of the grill element. • This mode can be used for grilling a smaller amount of open sandwiches, beer sausages, and for toasting bread. • Place the oven rack in the upper part of the oven and the baking tray in the middle of the oven. • Maximum allowed temperature 230 °C. • Monitor the cooking process at all times. The dish may burn quickly due to the high temperature. • Preheat for 5 minutes. 	
	<p>Large Grill</p> <ul style="list-style-type: none"> • Heating by means of the upper element and grill element. • This mode can be used with dishes and baked goods that require a distinctive bottom crust or browning. Use just before the end of the baking or roasting time. • Place the oven rack in the upper part of the oven and the baking tray in the middle of the oven. • Maximum allowed temperature 230 °C. • Monitor the cooking process at all times. The dish may burn quickly due to the high temperature. • Preheat for 5 minutes. 	
	<p>Large grill + fan</p> <ul style="list-style-type: none"> • Heating by means of the top heating elements. The heat is distributed by the fan. • This mode can be used for grilling meat, fish and vegetables. • Place the oven rack in the upper part of the oven and the baking tray in the middle of the oven. • Suggested temperature: 170 °C • Monitor the cooking process at all times. The dish may burn quickly due to the high temperature. • Preheat for 5 minutes. 	

Function	Description	
	<p>Pro Roasting</p> <ul style="list-style-type: none"> • This setting has an automatic heating cycle. • First the meat is sealed at a high temperature by means of hot air and the top heating element. • Then the dish is slowly cooked at the low, preset temperature, with the top and bottom heating elements. • This function is suitable for meat, poultry and fish. • Suggested temperature: 180 °C 	
Steam functions		
	<p>Steam</p> <ul style="list-style-type: none"> • Heating by means of steam. • See chapter 'Steam function' for more information. • Steam of 100 °C is sprayed into the oven cavity at regular intervals. • This mode can be used to steam vegetables, eggs, fruit and rice, for example. 	
	<p>Low temperature steam</p> <ul style="list-style-type: none"> • Heating by means of steam. • See chapter 'Steam function' for more information. • Steam is sprayed into the oven cavity at regular intervals. • This menu can be used to steam vegetables and fish, to keep food warm and defrost food. 	
	<p>Sous vide</p> <ul style="list-style-type: none"> • Heating by means of steam. • See chapter 'Steam function' for more information. • The vacuum-sealed food is slow-cooked at a low temperature. • With this method the food's flavour, vitamins and minerals are preserved. Vacuum sealing gives the dish a longer shelf life. • Use this function to cook vegetables, fruit, meat, poultry and fish. 	

Function	Description	
Combi steam functions		
 <p>High 3</p>  <p>Medium 2</p>  <p>Low 1</p>	<p>COMBI: Hot air + Steam level 1, 2, 3</p> <ul style="list-style-type: none"> • Heating by means of hot air in combination with steam. • The steam is sprayed into the oven cavity at regular intervals. • HIGH: cooking escalopes, steaks and smaller chunks of meat. • MEDIUM: reheating cool/frozen meals, cooking fish fillets and vegetables au gratin. • LOW: cooking large chunks of meat (roast, whole chicken), baking risen dough (bread and rolls), cooking lasagna etc. For this mode always make sure that the water reservoir is filled with fresh water. 	
Extra functions		
	<p>Fast preheat</p> <ul style="list-style-type: none"> • With this function, the oven cavity is quickly heated to the desired temperature. Do not use this setting when you have a dish in the oven. • Suggested temperature: 180 °C 	
	<p>Regenerate</p> <ul style="list-style-type: none"> • This mode is used to warm already cooked dishes. The use of steam means there is no loss of quality. Taste and texture are preserved as though the dish is freshly-cooked. Various dishes can be regenerated simultaneously. 	
	<p>Plate warming</p> <ul style="list-style-type: none"> • This function is used for warming tableware, so that the served food stays hotter for longer. • Suggested temperature: 60 °C 	
	<p>Defrost</p> <ul style="list-style-type: none"> • With this function, the air circulates by means of the fan. The air will be heated to a temperature of 30 °C. • Use this function to defrost frozen dishes. 	
	<p>Keep warm</p> <ul style="list-style-type: none"> • This function is used to keep already cooked dishes warm. • Suggested temperature: 60 °C 	

Function	Description	
	<p>Steam clean</p> <ul style="list-style-type: none"> • With this function and a damp cloth, you can easily remove grease and dirt from the oven walls. • Use this function only when the oven has cooled down fully. Steam is sprayed into the oven cavity at regular intervals. • After soaking, food residues can be removed using a damp cloth. 	

Culisensor

Roasting with the culisensor

For roasting with the culisensor, set the desired core temperature of the dish. The oven will heat up until the dish's core temperature is reached. The culisensor measures the core temperature of the dish.

1. Switch on the oven using the 'On/Off' button.
2. Remove the rubber cap from the connection point (front top corner of the right side wall).
3. Put the culisensor plug in the connection and insert the culisensor completely into the food.

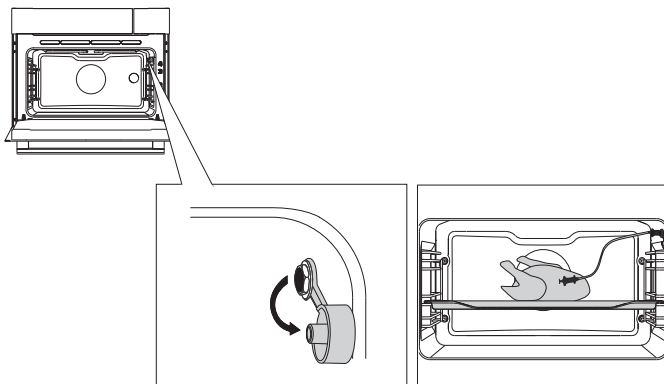

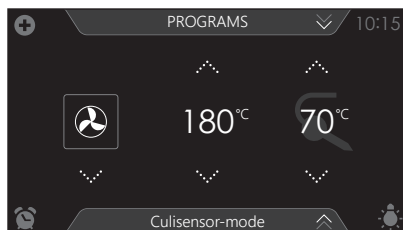

4. Select an oven function, temperature and core temperature (see 'Function-setting display' chapter).
5. Start cooking the dish using the confirm button.

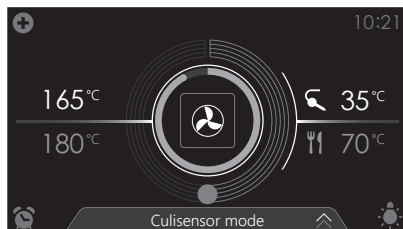

- The following values can now be read in the display:
 - ▷ current temperature (165 °C)
 - ▷ set temperature (180 °C)
 - ▷ status indicator core temperature (outer circle)
 - ▷ status indicator temperature (inner circle)
 - ▷ Current core temperature (35 °C)
 - ▷ Set core temperature (70 °C)
- The cooking process ends once the set core temperature is reached. At the end of a dish's cooking time a sound signal will sound. The signal can be switched off by opening the oven door or pressing a button.



- **Always place the culisensor's entire metal sensor in the dish.**
- **Please note! After the cooking process always replace the rubber cap on the culisensor's connection.**
- **Only use the culisensor in your oven.**
- **Ensure that the culisensor does not come into contact with the heating element during cooking.**
- **The culisensor will be extremely hot after the cooking process. Be careful! Avoid burns.**

Add steam

Steam can be added to the cooking process before cooking is started (Add steam 1-3X) or during cooking (Add steam). Both functions can be found in the 'Plus' menu in the oven function menu.

Add steam (1-3X) is recommended for cooking:

- meat: beef, veal, pork, game, poultry, lamb, fish, sausages (at the end of the cooking process).

An injection of steam will make meat juicier and softer without the need for basting.

- bread, bread rolls: use steam for the first 5-10 minutes of baking. The crust will then be crispy and nicely browned.
- vegetables and fruit soufflés, lasagna, starchy dishes, desserts.
- vegetables, particularly potatoes, cauliflower, broccoli, carrots, courgette, aubergine.

Add steam 1-3X

Up to three steam cycles can be selected. The automatic cycles are distributed evenly across the cooking process. It is therefore important that a cooking time is set!



- *This function is not available without setting a cooking time.*
- *When the cooking time is set too short, one or more options are not available.*

1. Select an oven function and set a cooking time (see 'Function setting-display' chapter).
2. Tap the plus symbol to open the 'Plus' menu.
3. Tap on 'Add steam 1-3X' to open the function.

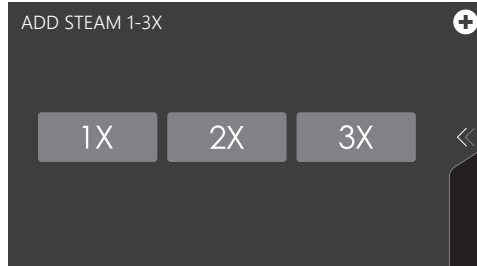

4. Tap on 1x, 2x or 3x to select the number of steam cycles.



5. Confirm the setting using the confirm button.
A small symbol will appear below the plus symbol indicating the selected number of steam cycles. The symbol (and the circle on the outer circle) changes colour during the steam cycle.
6. Start cooking using the confirm button.

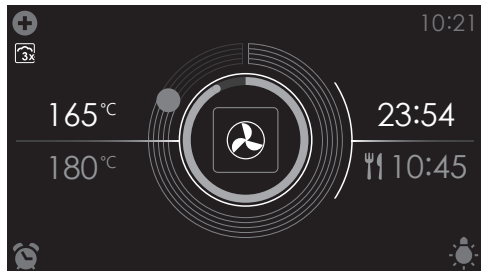

Small symbol indicating Add steam (1-3X) is activated.

Add steam

Add steam can be selected during cooking (after starting a function).
1 steam cycle will start immediately.

1. During cooking of a dish (using an oven function) tap the plus symbol to open the 'Plus' menu.
2. Tap on 'Add steam' to start a steam cycle.
A steam cycle will start immediately. A small symbol will appear below the plus symbol to indicate that the steam cycle has started. The symbol will disappear when the steam cycle ends. Another steam cycle can then be started.

Delayed start

Use the 'delayed start' function to start cooking at a later time.
The delayed start function can only be selected via the 'Plus' menu in a function. See the 'Using the 'Plus' menu' chapter.

Setting a delayed start time

1. Select a function, temperature and set a cooking time if necessary (see 'Function-setting display' chapter).



A delayed start time can also be set without setting a cooking time.

2. Tap the plus symbol to open the 'Plus' menu.
3. Tap on 'DELAYED START' to open the function.

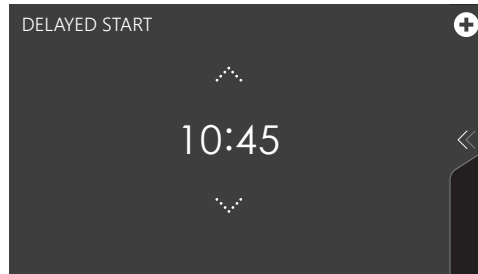

4. Select a start time (see 'Function-setting display' chapter).
5. Confirm the set start time using the confirm button.

The 'delayed start time' icon appears under the plus symbol to indicate activation. The delayed start time can be deselected by returning the setting to the current time.

6. Confirm the process using the confirm button.



The cooking will start automatically at the set time. If a cooking time has been set, the cooking will also switch off automatically.

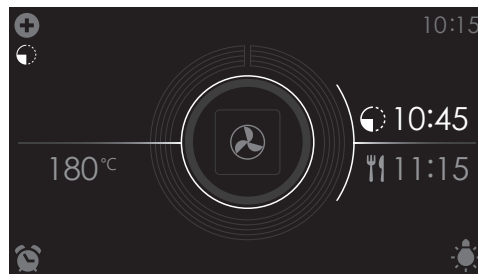

- The following values can now be read in the display:
 - set temperature (180 °C)
 - start time (10:45)
 - end time (11:15) (only visible if a cooking time has been set!)

Stage cooking

- Open the 'Stage cooking' menu via the 'Plus' menu. See the 'Using the 'Plus' menu' chapter.
 - This function allows you to combine up to three functions in one cooking process.
 - Select different functions and settings to compose the cooking process of your preference.
1. Tap the plus symbol to open the 'Plus' menu.
 2. Tap STAGE COOKING to open the function (can only be opened if no cooking has started). The stage 1 settings are visible. These can be adjusted if desired.

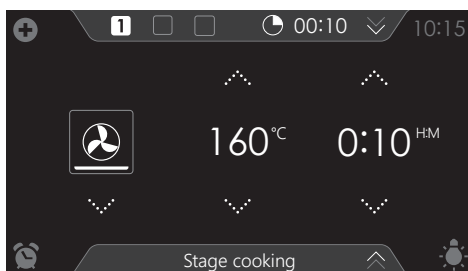

3. Select a function (see 'Function-setting display' chapter).
4. Select a temperature (see 'Function-setting display' chapter).
5. Select a cooking time (see 'Function-setting display' chapter).
6. Confirm the setting of stage 1 using the confirm button.

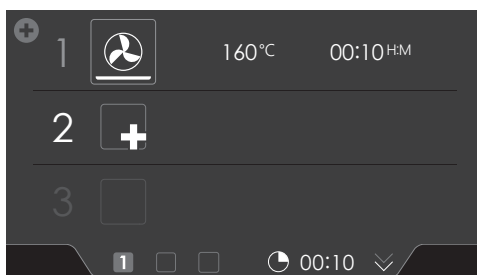

7. Tap on '2' to show the stage 2 settings.
8. If necessary, change the phase 2 default values (function, temperature and cooking time) (see points 3, 4 and 5).

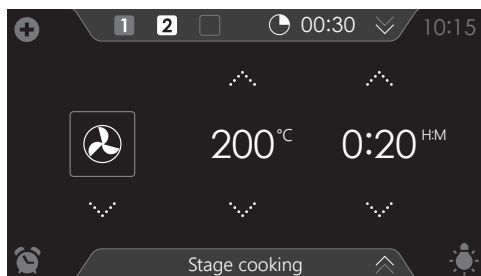

9. Confirm the setting of stage 2 using the confirm button.

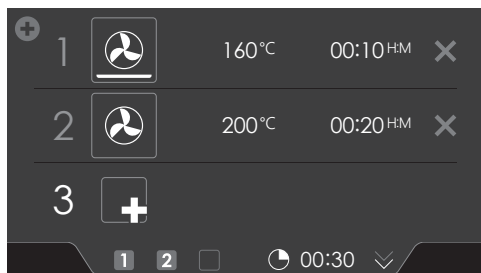

10. If desired, tap on '3' to show the stage 3 settings.

11. If necessary, change the stage 3 default values (function, temperature and cooking time) (see points 3, 4 and 5).

12. Confirm the setting of stage 3 using the confirm button.



Delete a stage by tapping on the cross next to the settings. A stage can only be deleted if it has not yet started.

13. By pressing the confirm button again, the oven starts to work according to stage 1 (the active stage is displayed in white).

When the set time has elapsed, the following stage will be activated, this being stage 2 and later stage 3 if this has been set.



The selected settings can be saved in 'Favourites'. For this open the 'ADD TO FAVOURITES' menu from the 'Plus' menu (See 'Saving a cooking method' in the 'Additional functions' chapter).

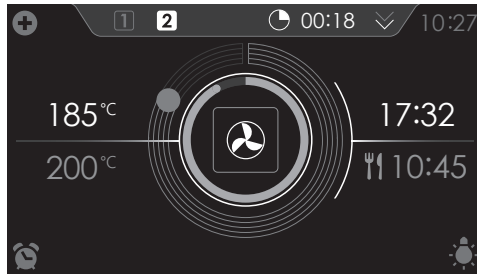

- The following values can now be read in the display:
 - ▷ active stage (2)
 - ▷ total remaining cooking time (00:18)
 - ▷ current temperature (185 °C)
 - ▷ active stage set temperature (200 °C)
 - ▷ active stage status indicator time (outer circle)
 - ▷ active stage status indicator temperature (inner circle)
 - ▷ active stage cooking time (17:32)
 - ▷ total end time (10:45)

Gratin

To add the grill function at the end of the progress (gratin time will be added at the end of the cooking process).

1. Tap the 'plus' symbol to open the 'Plus' menu .
2. Tap on 'GRATIN' to open the function.
3. The temperature and time can be set or the program can be started directly by pressing the confirm key.

Additional functions

Several additional functions or programs can be selected.

1. Tap on 'EXTRAS' to show the appliance's extra functions.

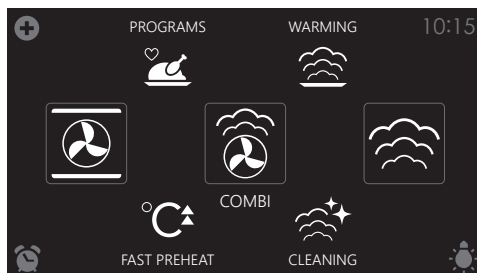

The following additional functions and programs can now be selected:

Warming

- Regenerate
 - This function is used to warm already cooked dishes. The use of steam means there is no loss of quality. Taste and texture are preserved as though the dish is freshly-cooked. Various dishes can be regenerated simultaneously.
- Plate warming
 - This function is used when you want to warm tableware (plates, cups) so that the served food stays hotter for longer.
 - By choosing this function you can determine the plate warming temperature and duration.
- Defrost
 - With this function, the air circulates by means of the fan. No heat elements are switched on.
 - Use this setting to defrost frozen dishes, such as cakes, bread and fruit.
- Keep warm
 - Use this function to keep already cooked food at temperature.
 - By choosing this function you can determine the keep warm temperature and duration.

Selecting warming functions

1. Tap on 'EXTRAS' to show the appliance's extra functions.
2. Tap on 'WARMING' to open the warming function menu.

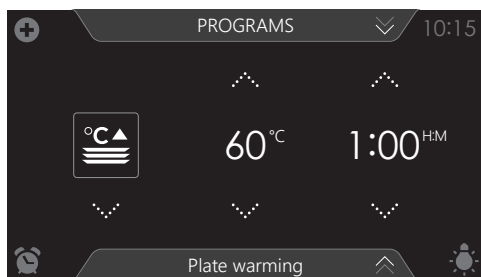

3. Choose the desired warming function (regenerate, plate warming, defrost or keep warm). Adjust the settings if necessary (see 'Function-setting display' chapter).

4. Start the function using the confirm button.



Programs:

- Favourites
 - You can select your own stored recipes in 'FAVOURITES'. See also 'Saving a cooking method'.
- Automatic programs
 - You can use 'automatic programs' for cooking by selecting a dish from a list of pre-programmed dishes. The programs are subdivided into categories (MEAT, VEGETABLES, etc.).
 - First select the category and then the dish itself from the available list.

Selecting program functions

1. Tap on 'EXTRAS' to show the appliance's extra functions.
2. Tap on 'PROGRAMS' to open the programs menu.

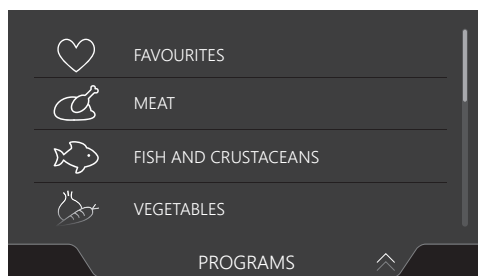

3. Tap on 'FAVOURITES' or one of the automatic program categories.
 - Select one of your saved dishes in 'FAVOURITES'.
 - Select a dish from the available list in the automatic programs.

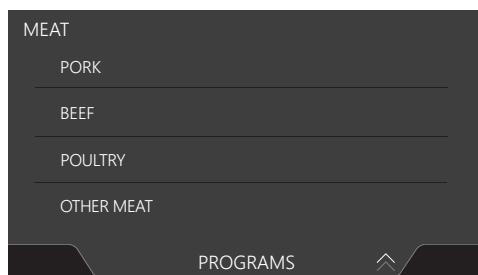

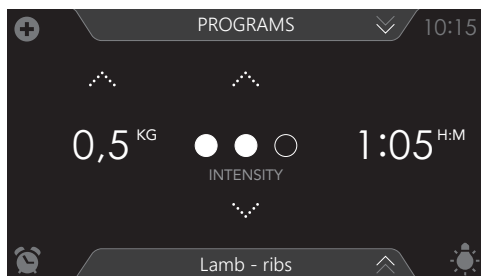

4. If necessary adjust the intensity and/or the weight.



The intensity or weight cannot be adjusted in all automatic programs.



5. Start the chosen program using the confirm key.

- *Open information about the chosen program using the info tab. Information about the required accessories and the shelf level in the oven can be read in this tab. Sometimes information about cooking the dish may also be found in this tab.*
- *For a number of automatic programs, it is sometimes possible to adjust settings manually. For adjusting the settings open the 'Plus' menu and tap 'MANUAL'.*

Saving a cooking method

A function/cooking method is active (the oven has started).

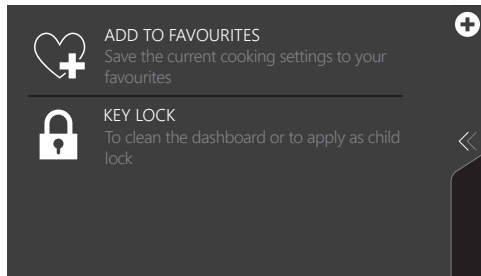

1. Open the 'Plus' menu and tap on 'ADD TO FAVOURITES'.

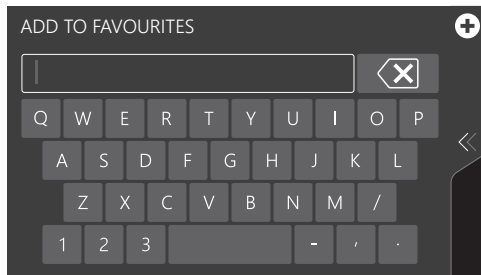

2. Give the dish you are preparing a name by selecting the appropriate letters. Tap on the 'arrow with cross' symbol if you wish to delete a letter.
3. Press on the confirm button to save the cooking method.



Automatic programs can also be saved under 'FAVOURITES'.

Settings

1. From the start display, tap on the plus symbol.

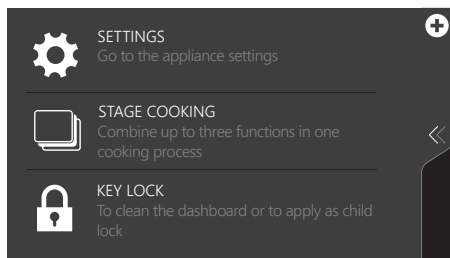

2. Tap on 'SETTINGS'.

This menu offers the following choices:

- General
- Sound
- Display and light
- Cooking
- System

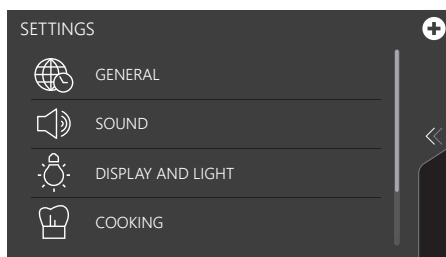

3. Tap on the desired category and the setting to be adjusted.

- Tap on the desired choice from a list.
- Adjust a value by tapping the arrows above and below the value or swiping over the value.
- Switch a setting on or off by tapping on 'ON' or 'OFF'.

4. Press the confirm button to confirm.



GENERAL

You can set the following from this menu:

- Language (language of the touch screen)

- Current time
- Time display (12 or 24-hour clock)
- Date (current date)
- Date display (date visible or not in the 'stand-by' display)

SOUND

You can set the following from this menu:

- General sounds (volume of sound signals and alarms)
- Key sounds (volume of key sounds)
- Start-up/shut-down sound (volume of start-up/shut-down sound)

DISPLAY AND LIGHT

You can set the following from this menu:

- Display brightness (adjustable in 5 brightness levels)
- Oven light (the time the light stays on after activation)
- Appliance to stand-by mode (the length of time before the appliance goes to stand-by after the last operation)
- Appliance switch off (how long the appliance stays in stand-by)
- Start-up/shut-down animation (start-up/shut-down of the brand animation)
- Night mode (start and end time for lower display brightness)



When for 'APPLIANCE SWITCH OFF' setting 'Manual' is selected, the appliance does not switch off automatically. When the device is switched off manually, this setting is put back to the factory setting. This is a mandatory maximum energy consumption regulation.

COOKING

You can set the following from this menu:

- Default program intensity (intensity of automatic programs)

SYSTEM

You can set the following from this menu:

- Appliance information (request appliance information)
- Water hardness (adjust the water hardness)
- Factory settings (back to factory settings)

Cleaning the appliance

Clean the oven regularly to prevent fat and food particles from accumulating, especially on the surfaces of the interior and the exterior, the door and the seal.

- Activate the child lock (to prevent that the appliance is switched on accidentally).
- Clean the exterior surfaces with a soft cloth and warm soapy water.
- Next wipe with a clean, damp cloth and dry the surfaces.
- Remove splashes and stains on the interior surfaces with a cloth and soapy water.
- Next wipe with a clean, damp cloth and dry the surfaces.



Important

- Make sure that no water enters the vents.
- Never use abrasive cleaning materials or chemical solvents.
- Always make sure that the seal of the door is clean. This prevents accumulation of dirt and allows you to close the door properly.

Steam clean

With the steam clean function and a damp cloth, you can easily remove grease and dirt from the oven walls.

Using steam clean

Only use steam clean when the oven has cooled down fully. It is more difficult to remove dirt and grease if the oven is hot.

1. Remove all accessories from the oven.
2. Tap on 'EXTRAS' to show the appliance's extra functions.
3. Tap on 'CLEANING' to open the cleaning function.
4. Press on the confirm key to start steam clean.



- *Do not open the door during the cleaning process.*
- *The process takes 30 minutes.*
Food remains on the enamel walls will be sufficiently soaked after 30 minutes so that they can be removed with a damp cloth.

Cleaning the water tank filter

If the water tank filter is dirty, you can clean it under the tap.

1. Remove the suction tube with the filter.
2. Clean it out under the tap and put it back into position. Ensure that the filter touches the base of the water tank.

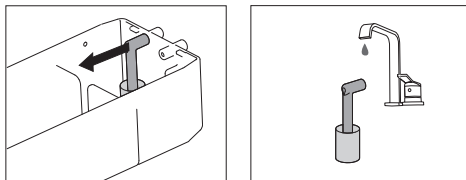

Descaling

During the steam process, there can be an accumulation of mineral deposit in the steam system. This needs to be removed from time to time. You need to carry out this task when the 'Appliance needs descaling' notification is shown.

If the appliance is not descaled after three notifications, the steam functions will no longer be available. Use this function only when the oven has cooled down fully. The descaling process comprises descaling and rinsing. Notifications with information and requests for actions will be shown on the display during the process.

1. Tap on 'EXTRAS' to show the appliance's extra functions.
2. Tap on 'CLEANING' to open the cleaning function.
3. Choose 'Descaling' to select the function.
4. Press on the confirm button to start descaling.

Note

We advise using NOKALK/DLS for descaling. NOKALK/DLS is an extremely efficient descaling agent based purely on natural, entirely biodegradable ingredients. The solution is non-corrosive, not aggressive and is environmentally-friendly.

As well as an effective descaling action, it also has a cleansing and anti-bacterial effect, ensuring that the appliance's internal components are preserved in an optimum hygienic state. Therefore food's good taste is preserved and the appliance's service life is extended.

CLEANING

- Water is used for the steaming process. Water contains calcium and magnesium. Heat causes the water to condense, leaving a mineral deposit (not harmful to humans).
- If the descaling cycle is interrupted prior to the end of the cycle, the program must be restarted from the beginning.

Removing and cleaning the guide rails

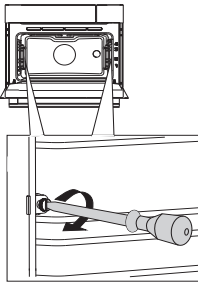

Use conventional cleaning products to clean the guide rails.

- Remove the screw using a screwdriver.
- Remove the guide rails from the holes in the back wall.

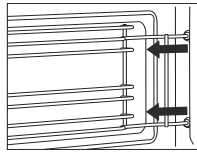

Replacing the oven light bulb



The lamp in this household appliance is only suitable for illumination of this appliance. The lamp is not suitable for household room illumination.

The light bulbs (2x) (halogen G9, 230 V, 25 W) are a consumer items and therefore not covered by warranty. To replace it, first remove the baking tray, oven rack and guide rails.

Halogen lamp: G9, 230 V, 25 W

The oven is fitted with a halogen lamp.

This product contains a light source of energy efficiency class (G).



Disconnect the appliance from the power supply by removing the plug from the socket or by switching off the circuit breaker in the fuse box.

Please note: the light bulb can be very hot! Use protection to remove the bulb.

1. Remove the four screws from the cover panel. Remove the cover panel and glass.
2. Remove the light bulb and install a new one.
To prevent burns, use protection to remove the light bulb.
3. Do not remove the seal from the cover panel.

The seal should not become loose from the cover panel. The seal must fit perfectly in the oven wall recess.

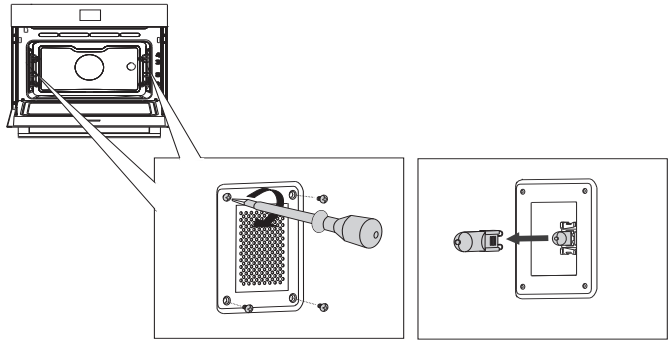

Removing the oven door



Keep your fingers away from the hinges of the oven door. The hinges are spring loaded and can cause injury if they spring back. Make sure that the hinge latches are applied correctly to lock the hinges.

Remove the oven door

1. Open the door to the fully open position.
2. Lift both hinge latches (A) and pull them towards the oven door (B).
The hinges will be locked in the 45° position.
3. Gently close the door until it reaches a 45° angle.
4. Remove the door by lifting and tilting it towards the oven (C). The hinges need to come out of the slots in the oven.

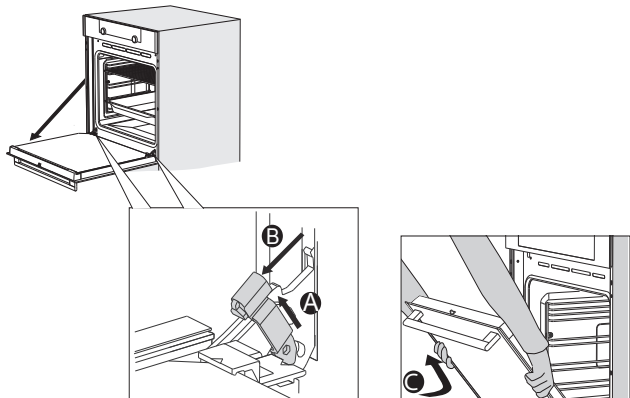

Install the oven door

1. Hold the door at an angle of approximately 45° in front of the oven.
2. Insert the hinges into the slots and make sure they are both positioned correctly.
3. Open the door to the fully open position.
4. Lift both hinge latches and move them towards the oven.
5. Gently close the oven door and make sure that it closes correctly.

If the door does not open or close correctly, then make sure that the hinges are positioned correctly in their slots.

Removing the oven door glass

The inside of the glass in the oven door can be cleaned. For this it must be removed from the oven door.

1. Slightly lift (1) and shift (2) the clamps at the lower left and right of the door to release the glass (A).
2. Grab the glass (A) at the bottom and gently lift (3) and shift (4) it to remove it from the upper support.
3. The inner glass (B) (depending on the model) can be removed by carefully lifting (5) and shifting (6) it to removing it from the lower support. Also remove the rubber spacers (C) from the inner glass.

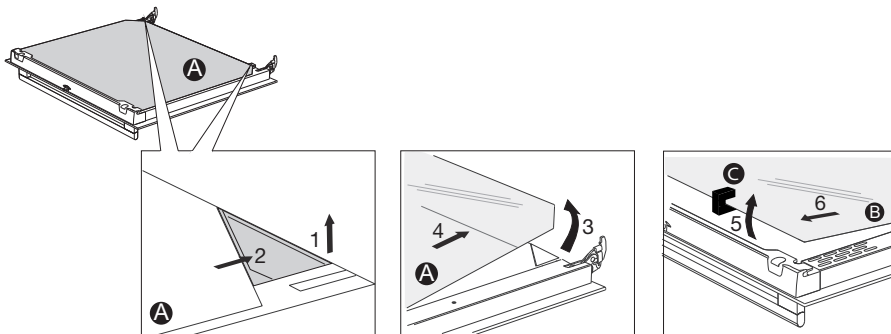

Install the glass in reverse order.

General

If you have problems with your oven, then consult the error overview below. Should the problems persist, then please contact the Customer Services Department.

The food stays raw

- Check whether the timer has been set and you have pressed the 'confirm key'.
- Is the door closed properly?
- Check whether a fuse has blown or a circuit breaker has been activated.

The food is overcooked or undercooked

- Check whether the correct cooking time has been set.

The keys do not respond; the display does not respond to the keys.

- Disconnect the appliance from the power supply for a few minutes (remove the mains plug from the socket or switch the circuit breaker to off); then reconnect the appliance and switch it on.

Power failure can cause the display to reset.

- Disconnect the appliance from the power supply for a few minutes (remove the mains plug from the socket or switch the circuit breaker to off); then reconnect the appliance and switch it on.
- Set the time again.

There is condensation in the oven.

- This is normal. Wipe the oven clean after use.

The fan keeps working after the oven is switched off.

- This is normal. The fan will keep working for a while after the oven is switched off.

Air flow can be felt at the door and the exterior of the appliance.

- This is normal.

Steam escapes via the door or the vents.

- This is normal.

Clicking sounds can be heard when the oven is working, particularly in the defrost setting.

- This is normal.

The circuit breaker switches off regularly.

- Consult a service technician.

The display gives an error code, ERROR XX ...

(XX indicates the number of the error).

- There is a fault in the electronic module. Disconnect the appliance from the power supply for a few minutes. Then reconnect it and set the current time.
- Consult a service technician if the error persists.

Storing and repairing the oven

Repairs should only be performed by a qualified service technician.

If maintenance is required, then remove the mains plug from the socket and contact the Asko customer service.

Have the following information to hand when you call:

- The model number and serial number (stated on the inside of the oven door)
- Warranty details
- A clear description of the problem



Choose a clean, dry place if you have to store the oven temporarily, as dust and moisture can damage the appliance.



When steam function is in use, opening the door will release an amount of steam. It's recommended to not open the door until the program is finished.

Disposal of the appliance and packaging

This product is made from sustainable materials. However, the appliance must be disposed of responsibly at the end of its useful life. The government can provide you with information about this.

The packaging of the appliance can be recycled. The following materials have been used:

- cardboard
- polyethylene wrap (PE)
- CFC-free polystyrene (hard PS foam)

Dispose of these materials responsibly in accordance with legal provisions.



The product has a pictogram of a rubbish bin with a cross through it. This indicates that household appliances must be disposed of separately. This means that the appliance may not be processed via the regular waste flow at the end of its useful life. You should take it to a special municipal waste depot or a sales outlet that offers to do this for you.

Collecting household equipment separately prevents harm to the environment and public health. The materials used in manufacturing this appliance can be recycled, which provides considerable savings in energy and raw materials.

Declaration of conformity



We hereby declare that our products comply with the relevant European directives, standards and regulations as well as all requirements referred to in the standards.

 **ASKO**



688759

en (09-23)